



**DOUBLE SIDEBURNER
Model# 3282(P)T**

**INSTALLATION AND OPERATING
INSTRUCTIONS**

INSTALLER: Leave these instructions with consumer.
CONSUMER: Retain for future reference.



Important: READ THESE INSTRUCTIONS CAREFULLY BEFORE STARTING INSTALLATION

SAFETY WARNINGS & CODES

⚠ DANGER
IF YOU SMELL GAS:
1. Shut off the gas to the appliance.
2. Extinguish any open flame.
3. Open cover.
4. If odor continues, keep away from the appliance, and **immediately** call your gas supplier or fire department.

⚠ WARNING
1. Do not store or use gasoline or other flammable vapors and liquids in the vicinity of this or any other appliance.
2. A propane cylinder not connected for use shall not be stored in the vicinity of this or any other appliance.

CODE AND SUPPLY REQUIREMENTS: This appliance must be installed in accordance with local codes and ordinances, or, in the absence of local codes, with either the latest *National Fuel Gas Code (ANSI Z223.1/NFPA 54)*, and *Natural Gas and Propane Storage and Handling Installation Code (CSA-B149.1)*.

WARNING
Improper installation, adjustment, alteration, service, or maintenance can cause injury or property damage. Refer to this manual. For assistance or additional information consult a qualified professional service technician, service agency, or the gas supplier.

This appliance and its individual shutoff valves must be disconnected from the gas supply piping system when testing the system at pressures in excess of ½ psig (3.5 kPa).

All electrical outlets in the vicinity of the appliance must be properly grounded in accordance with local codes or, in the absence of local codes, with the **National Electrical Code, ANSI/NFPA 70, or the Canadian Electrical Code, CSA C22.1**, whichever is applicable.

This appliance must be isolated from the gas supply piping system by closing its individual manual shutoff valves during any pressure testing of the gas supply system at pressures up to and including ½ psig (3.5 kPa).

Keep all electrical supply cords and fuel supply hoses away from any heated surface.

Certified to: **ANSI Z21.58-2015**
CSA 1.6-2015



**INSTALLATION INSTRUCTIONS ET MANUEL DU PROPRIÉTAIRE
DANS LE CONTRE- DOUBLE SIDEBURNER****▲ DANGER:****SI VOUS SENTEZ LE GAZ :**

1. Coupez l'admission de gaz de l'appareil.
2. Éteindre toute flamme nue.
3. Ouvrir le couvercle.
4. Si l'odeur persiste, éloignez-vous de l'appareil et appelez immédiatement le fournisseur de gaz ou le service d'incendie.

CONDITIONS DE CODE ET D'APPROVISIONNEMENT:

Ce gril doit être installé selon des codes et des ordonnances locaux, ou, en l'absence des codes locaux, avec l'un ou l'autre le plus défunt *Code national de gaz de carburant* (norme ANSI Z223.1/NFPA 54), et *Stockage de gaz naturel et de propane et manipulation du code d'installation* (CSA-B149.1).

Cet appareil et ses différents robinets d'isolement doivent être démontés du gaz-fournissent le système sifflant en examinant le système aux pressions au-dessus du ½ psig (kPa 3.5).

Cet appareil doit être isolé dans gaz-fournissent le système sifflant par fermeture que ses différents robinets d'isolement manuels pendant tous les essais sous pression du gaz-fournissent le système aux pressions jusques et y compris le ½ psig (kPa 3.5).

- Ce gril est pour utilisation à l'extérieur seulement. Si l'appareil est entreposé à l'intérieur, enlever les bouteilles et les laisser à l'extérieur.
- Ne pas ranger le gril immédiatement après l'avoir utilisé. le laisser refroidir avant de le déplacer ou de la ranger. Le non respect de cette mesure de sécurité pourrait entraîner un incendie causant des dommages à la propriété, des blessures ou la mort.
- Ne pas utiliser cet appareil sous une surface combustible.
- Ne pas utiliser cet appareil sous un auvent. Le non respect de cette mesure de sécurité pourrait entraîner un incendie ou des blessures.
- Dégagement minimal entre les parois latérales et l'arrière de l'appareil et la construction combustible (45.7 cm à partir des parois latérales et 45.7cm à partir de l'arrière).
- Le régulateur de pression de gaz prévu avec cet appareil de cuisson à gaz pour l'extérieur doit être utilisé. Ce régulateur est réglé pour une pression de sortie de 5 pouces de colonne de l'eau pour le gaz naturel, et 10 pouces pour le propane.
- LE RÉGULATEUR INCLUS D'APPAREILS EST ÉVALUÉ POUR LE MAXIMUM DE 1/2 (LIVRES PAR POUCE CARRÉ). SI VOTRE OFFRE DE GAZ EST 1/2 PLUS GRAND QUE (LIVRES PAR POUCE CARRÉ), UN RÉGULATEUR ADDITIONNEL DOIT ÊTRE INSTALLÉ AVANT LE GRIL. VOIR LA SECTION DE CONDITIONS D'OFFRE DE GAZ POUR LA PRESSION APPROPRIÉE D'OFFRE DE GAZ.

▲ AVERTISSEMENT:

1. Ne stockez pas ou n'employez pas l'essence ou d'autres vapeurs et liquides inflammables à proximité de ceci ou d'aucun autre appareil.
2. Un cylindre de propane non relié pour l'usage ne sera pas stocké à proximité de ceci ou d'aucun autre appareil.

▲ AVERTISSEMENT:

L'installation inexacte, l'ajustement, le changement, le service, ou l'entretien peuvent causer des dommages ou des dégâts matériels. Référez-vous à ce manuel. Pour de l'aide ou de l'information complémentaire, consulter un technicien professionnel qualifié de service, une agence de service ou le fournisseur de gaz.

Toutes les sorties électriques à proximité du gril doivent être correctement fondues selon des codes locaux, ou en l'absence de local code, avec le code électrique national, ANSI/NFPA 70, ou le code électrique canadien, CSA C22.1, celui qui est applicable.

Maintenez tout électrique-fournissent des cordes et carburant-fournissent des tuyaux partis de n'importe quelle surface de chauffage.

- Ne couvrez jamais la surface entière de cuisine ou de gril de gauffreuses ou de casseroles. La surchauffe se produira et les brûleurs ne seront pas très performants quand la chaleur de combustion est emprisonnée au-dessous de la surface à cuire.
- Ne pulvérisez jamais l'eau sur une unité chaude de gaz, comme ceci peut endommager des composants de porcelaine ou de fer de fonte.
- Une fuite de GPL peut causer une incendie ou une explosion si enflammée entraînant des blessures corporelles graves ou la mort.
- Communiquez avec le fournisseur de GPL pour les réparations ou pour disposer de qules bouteille ou du GPL non utilisé.

**Certifié à la norme: ANSI Z21.58-2015
 CSA 1.6-2015**

**INSTALLATEUR : Laissez ces instructions avec le consommateur.
CONSOMMATEUR : Maintenez pour la future référence.**

GETTING STARTED

SAFETY WARNINGS & CODES.....	1
DOUBLE SIDEBURNER PARTS LIST	4
MODEL SPECIFICATIONS.....	5
<i>MODEL SPECIFICATIONS TABLE</i>	5
<i>COUNTERTOP OVERHANG</i>	5
<i>COMBUSTIBLE ENCLOSURE CUT-OUT</i>	6
<i>SUBSTRATE</i>	6
<i>DOUBLE SIDEBURNER DIMENSIONS TABLE</i>	7
MAINTENANCE AND SAFETY INFORMATION	8
INSTALLATION REQUIREMENTS	9
<i>OVERHEAD CONSTRUCTION REQUIREMENTS</i>	9
<i>SIDE AND REAR WALL CLEARANCES</i>	9
<i>BACKSPASH CLEARANCE (IF APPLICABLE)</i>	9
<i>ENSURE PROPER COMBUSTION AIR AND COOLING AIRFLOW</i>	10
<i>GAS-SUPPLY PLUMBING REQUIREMENTS</i>	10
ENCLOSURE REQUIREMENTS.....	11
<i>VENTILATION (ALL ENCLOSURES)</i>	11
<i>WHEN A PROPANE CYLINDER IS USED</i>	11
PROPANE SAFETY INFORMATION	12
OPERATING THE UNIT SAFELY AND CORRECTLY	12
<i>WARNING</i>	12
<i>INSTALLATION SAFETY GUIDELINES</i>	12
SAFE USE & MAINTENANCE OF PROPANE GAS CYLINDERS.....	13

INSTALLATION

INSTALLATION	15
<i>COUNTER PREPARATION</i>	15
<i>CONNECT THE GAS SUPPLY</i>	15
<i>SLIDE UNIT INTO ENCLOSURE</i>	16
<i>POSITION THE BURNER CAPS</i>	16
<i>INSTALL THE COOKING GRID</i>	16
<i>INSTALL THE BURNER COVER</i>	16
NOTES PAGE	17

USE, CARE, & SERVICE

LIGHTING (IGNITION) INSTRUCTIONS.....	19
<i>ELECTRONIC LIGHTING</i>	19
<i>MANUAL LIGHTING</i>	19
<i>SHUTTING OFF THE UNIT</i>	19
CARE & CLEANING	20
AIR SHUTTER ADJUSTMENT	23
AIR SHUTTER ADJUSTMENT	23
CONTROL PANEL REMOVAL	24
VALVE "LOW" SETTING ADJUSTMENT.....	25
NOTES PAGE	26
TROUBLESHOOTING.....	27
WARRANTY	28

DOUBLE SIDEBURNER PARTS LIST

Item	Description	Part No.	Qty.
1.	Double sideburner cover	3281-07	1
2.	Porcelain cast iron cooking grid	3529	1
OR	Stainless steel cooking grid	3529-S	1
3.	Burner assembly (w/ burner pipe)	3279-32	2
4.	Burner cap (only)	3279-36	2
5.	Control panel	3282T-05	1
6.	Valve manifold assembly	3282T-22	1
7.	Burner valve w/ igniter assembly	3282T-49	1
8.	Flex connector w/ fittings *	3031	1
9.	Control knob	24-B-38T	2
10.	Convertible regulator *	PR-4	1
11.	Natural gas orifice *	3001-53	2
12.	Propane gas orifice *	3001-59	2

* Not shown

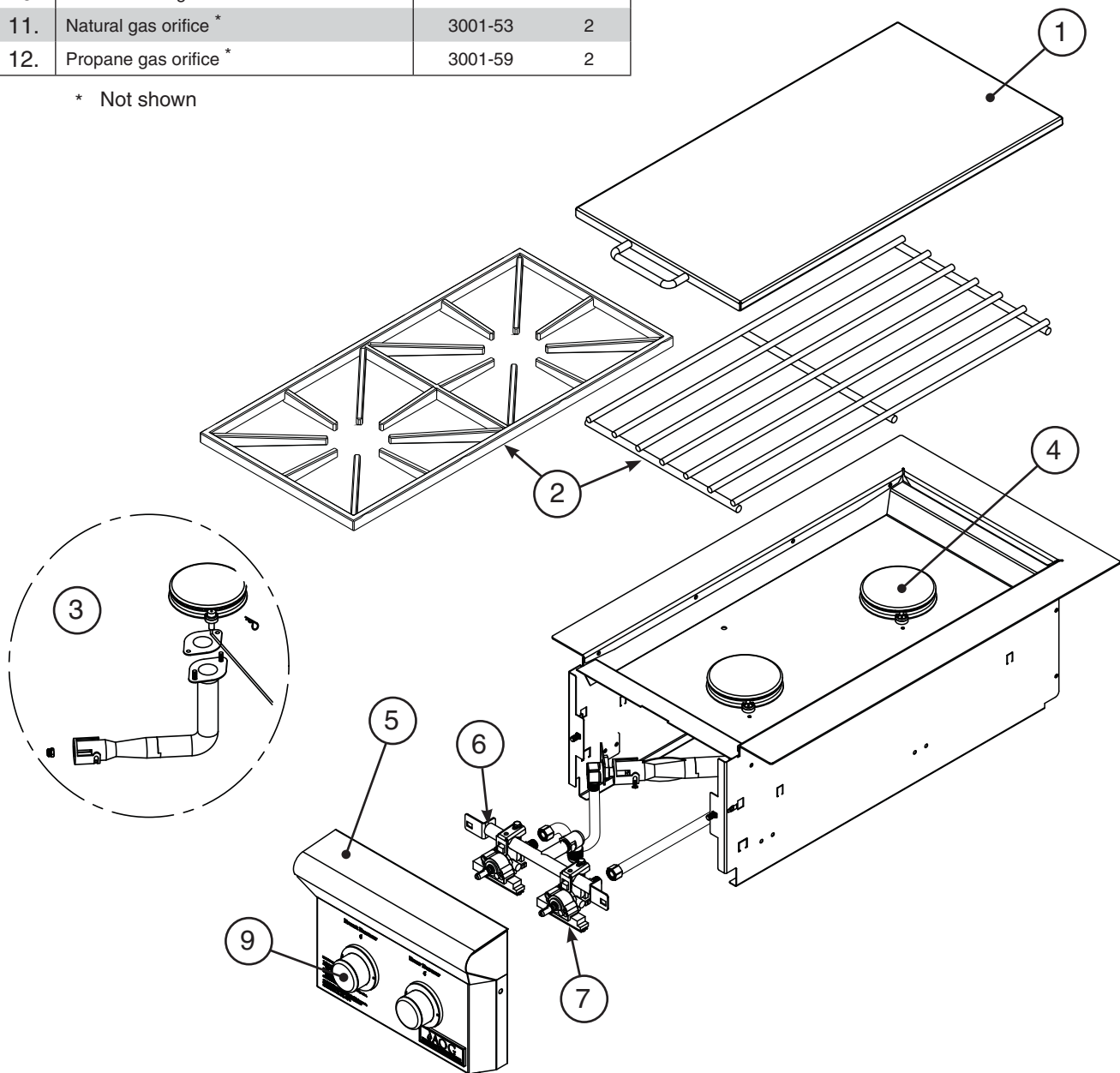

MODEL SPECIFICATIONS

MODEL SPECIFICATIONS TABLE

Table 1		Non-combustible enclosures	Combustible enclosures
Main burner quantity		2	
N/P orifice drill size		#53 / #59	
A Countertop to unit bottom cut-out		8-1/2"	8-1/2"
B Side to side cut-out		11-1/2"	12" [▲]
C Front to back cut-out †		22-3/4"	23-1/4" [▲]
D Control panel width cut-out ‡		12-5/8"	12-5/8"

▲ The increased dimensions for combustible enclosures allow for a required air gap along the sides and rear of the unit. See the COMBUSTIBLE ENCLOSURE CUT-OUT section on the next page for details.

† Includes any substrate at front wall of enclosure (in the area the rear of the control panel is to sit flush against). See SUBSTRATE section on next page.

‡ Only applicable for enclosures that have countertops with an overhang (see illustration and section below).

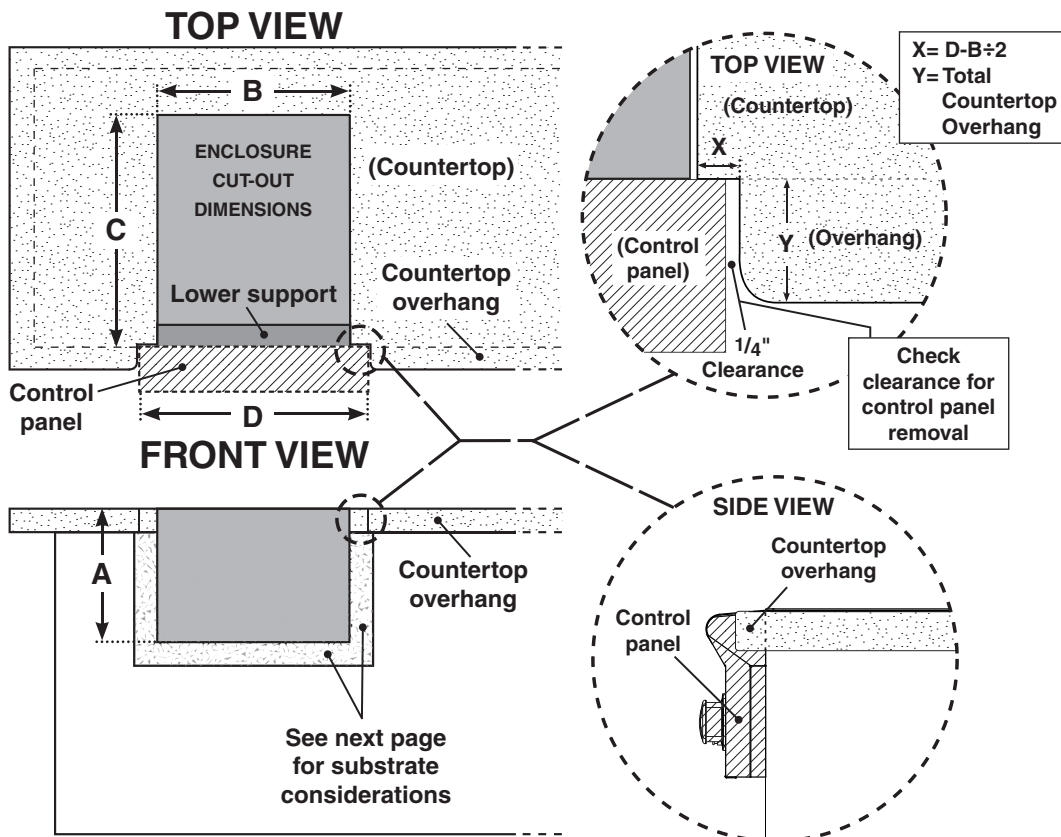

Fig. 5-1

COUNTERTOP OVERHANG

The control panel is designed to sit flush against the enclosure front wall. If the enclosure countertop extends beyond the front wall, creating a countertop overhang, it must be cut flush with the front wall for the width of the control panel or a gap will be created exposing the forward portions of the left and right side fire walls of the unit. See illustrations above.

Important: FOR YOUR SAFETY, you must provide openings in the island enclosure for drainage, replacement air, and cross-ventilation of any storage area exposed to possible leakage from gas connections, the unit, or propane tanks. See the ENCLOSURE REQUIREMENTS section for details.

COMBUSTIBLE ENCLOSURE CUT-OUT

This unit may be installed into combustible framing (wood, for instance) provided there is a minimum of a 1/2" airspace between ALL sides of the unit and any combustible material.

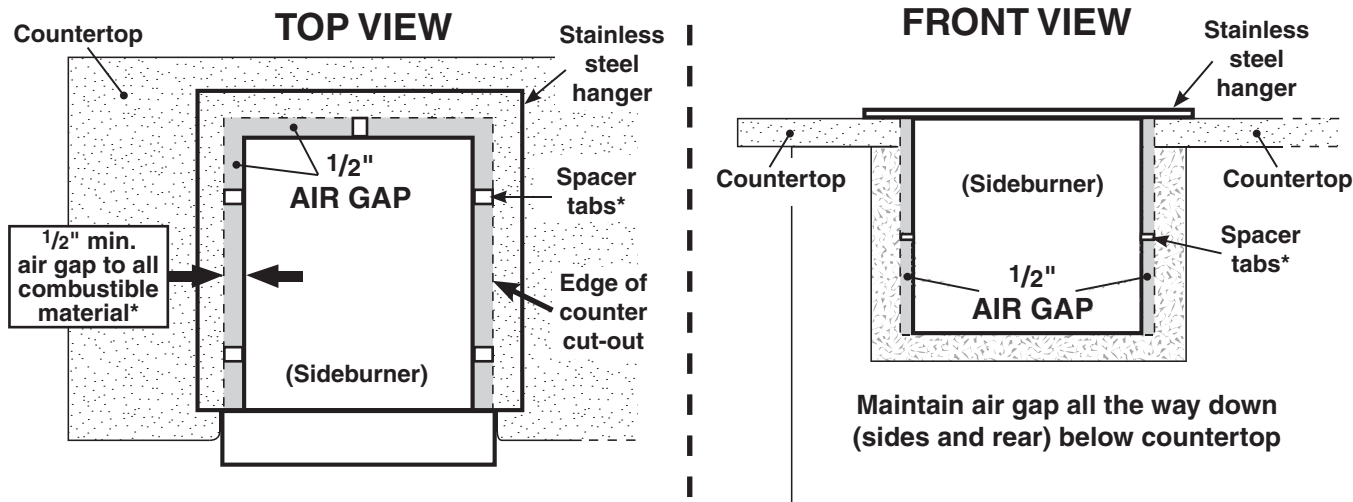

* Use the spacer tabs located on the side and rear walls of the unit to assist in this required clearance.

Fig. 6-1

SUBSTRATE

When adding any substrate to the enclosure front wall (including tiles, stone, etc.), consider the following:

Substrate Behind Control Panel

Substrate + countertop "front to back" cutout must equate to **Dim. C** (see previous page) when the substrate sits flush behind the control panel.

Substrate Alongside Control Panel

Any additional substrate alongside the control panel does not need to be considered in **Dim. C** (see previous page), however a 1/4" clearance on each side (same as overhang) and below is required.

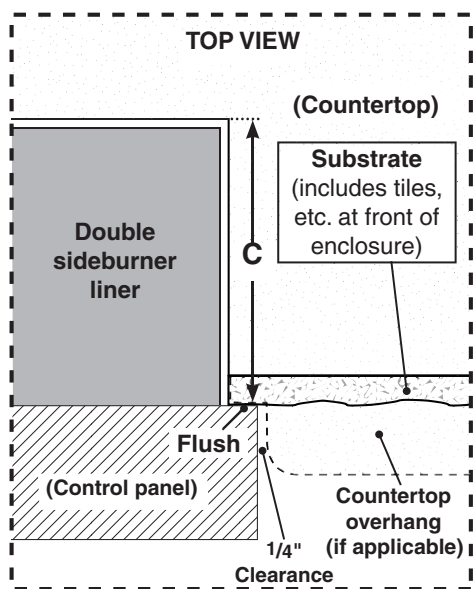

Fig. 6-2

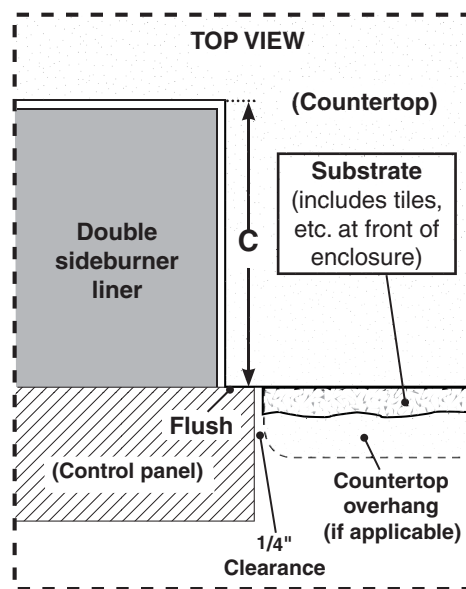

Fig. 6-3

MODEL SPECIFICATIONS (cont.)

DOUBLE SIDEBURNER DIMENSIONS TABLE

Height	Width		Depth
(Top to bottom)	(Left to right)		(Front to back)
Top of hanger to bottom of unit (E)	Hanger to hanger (F)	Control panel width (G)	Maximum depth (H)
8 5/8"	15 1/2"	12 1/8"	26 1/4"

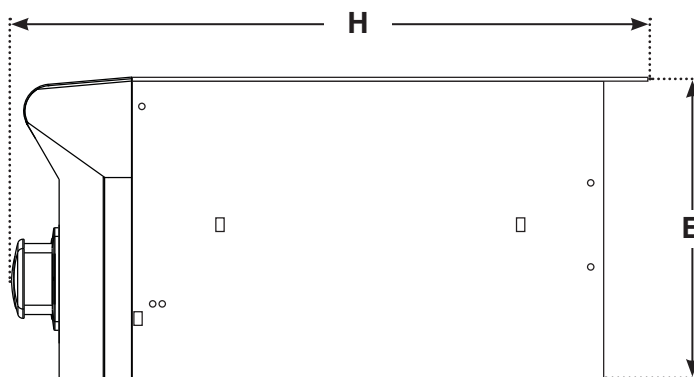
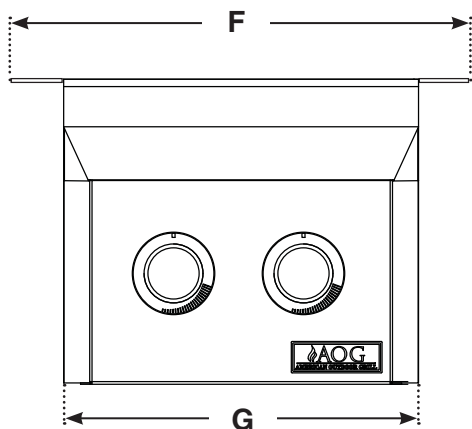

Fig. 7-1

MAINTENANCE AND SAFETY INFORMATION

1. The double side burner and surrounding area **MUST** remain clear of flammable substances such as gasoline, yard debris, wood, etc.
2. The airflow through the vent space located below the control panel must remain unobstructed.
3. **When using propane gas:**
 - a. **The required ventilation openings in the enclosure must be clear of debris. See the PROPANE SAFETY INFORMATION section.**
 - b. **The propane cylinder, regulator, and rubber hose must be in a location not subject to temperature above 125° F (51° C).**
4. **Do not operate the burner with the cover in place.**
5. The flames on each burner burn evenly along the burner caps with a steady flame (mostly blue). If burner flames are not normal, check and clean the orifice and burner/venturi tubes for insects and insect nests. A clogged tube can lead to a fire beneath the unit. A proper flame pattern will ensure safe operation and optimal performance. Adjust the air shutter as needed (see AIR SHUTTER ADJUSTMENT).
6. The in-line gas valve or gas cylinder valve must always be shut OFF when the unit is not in use.

IMPORTANT

IN THE EVENT OF A GREASE FIRE, IMMEDIATELY SHUT OFF THE MAIN GAS VALVE TO THE UNIT. KEEP THE LID OPEN AND ALLOW THE FIRE TO EXTINGUISH ITSELF. A THOROUGH INSPECTION BY A TRAINED SERVICE TECHNICIAN SHOULD BE CONDUCTED BEFORE FUTURE USE OF YOUR UNIT. THE SERVICE TECHNICIAN WILL CHECK THE SYSTEM FOR GAS LEAKS AND WILL CHECK ALL ELECTRICAL WIRING FOR DAMAGE. ALL GAS LEAKS AND WIRING MUST BE REPAIRED PRIOR TO FUTURE USE.

WARNING: NEVER cover more than 75% of the cooking surface with griddles or pans. Overheating will occur, and burners will not perform properly when combustion heat is trapped below the cooking surface.

CAUTION: NEVER spray water on a hot gas unit.

**The unit serial number and unit rating label are located on the inside of the control panel.
The unit must be completely cool before opening.**

INSTALLATION REQUIREMENTS

Installation must be performed by a qualified professional service technician.

This unit is designed for outdoor use only. **DO NOT** use this unit inside a building, garage, or enclosed area. **DO NOT** use this unit in or on a recreational vehicle or boat.

When installing this unit in a combustible enclosure, the correct air gap requirement must be met.

The unit must have a minimum clearance of 18" from combustible materials/items AT ALL TIMES.

OVERHEAD CONSTRUCTION REQUIREMENTS

A minimum 5 foot clearance is required between the countertop and the overhead construction (Fig. 9-1).

SIDE AND REAR WALL CLEARANCES

For the minimum clearances between the sideburner and any side or rear walls, your setup must fall within one (or more) of the following:

A. Clearance between sideburner and strictly non-combustible wall

(i.e. brick wall, see Fig. 9-2)

- The unit must have a minimum of 4" right, left, and rear clearance from any non-combustible wall. (To allow for proper ventilation and prevent dangerous overheating.)

B. Clearance between sideburner and a protected combustible wall

(i.e. a non-combustible wall in front of a combustible wall to serve as a barrier. This can be accomplished by brick, or a metal stud finished with non-combustible substrate, see Fig. 9-3)

- The unit must have a minimum of 14" right, left, and rear clearance from the protected combustible wall. (The 4" non-combustible material plus an additional 10" clearance between the sideburner and protected wall.)

C. Clearance between sideburner and combustible wall

- The unit must have a minimum of 18" right, left, and rear clearance from any combustible wall (see Fig. 9-4).

BACKSPASH CLEARANCE (IF APPLICABLE)

If a non-combustible backsplash exists, it must have a minimum of a 4" clearance from the rear of the unit (to allow for proper ventilation and prevent dangerous overheating). See Fig. 9-5.

Important: This 4" backsplash clearance must first be met prior to any non-combustible walls beginning behind it.

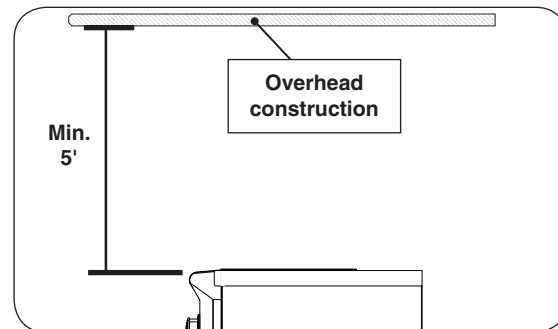

Fig. 9-1 Overhead requirements

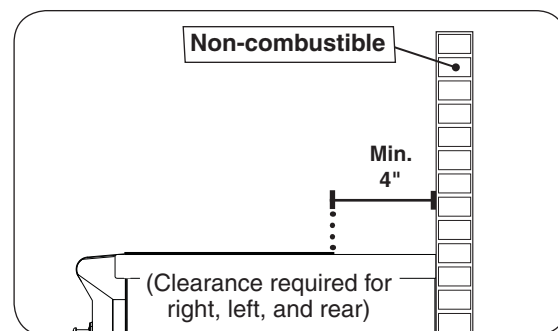

Fig. 9-2 Clearance 'A' Diagram

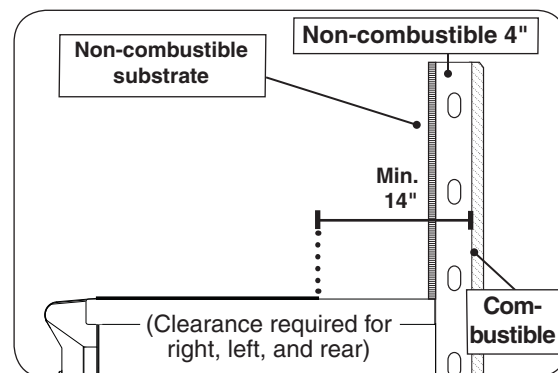

Fig. 9-3 Clearance 'B' Diagram

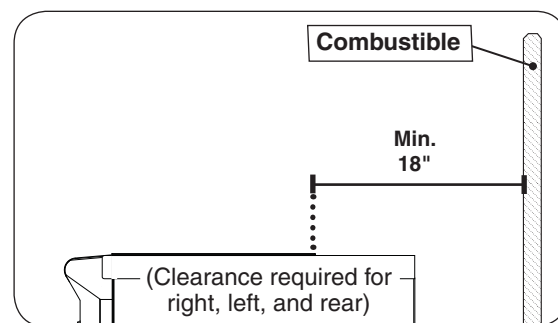

Fig. 9-4 Clearance 'C' Diagram

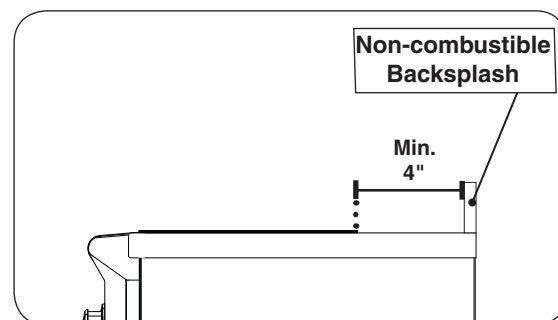

Fig. 9-5 Backsplash clearance

INSTALLATION REQUIREMENTS (cont.)

The control panel **MUST** remain removable for servicing (see PARTS LIST).

ENSURE PROPER COMBUSTION AIR AND COOLING AIRFLOW

Proper airflow (Fig. 10-1) **MUST** be maintained for the sideburner to perform as it was designed. If airflow is blocked, overheating and poor combustion will result. Do not block the 1" front air inlet along the bottom of the control panel or more than 75% of the cooking grid surface with pans or griddles.

GAS-SUPPLY PLUMBING REQUIREMENTS

For natural gas or a household propane system, rigid $\frac{1}{2}$ " or $\frac{3}{4}$ " black steel pipe or local code-approved pipe is required to conduct the gas supply to the unit. Contact your local gas supplier. Connect this pipe to a required C.S.A.-approved stainless-steel flex connector (included). **DO NOT use a rubber hose within the unit enclosure.** Apply only joint compounds that are resistant to all gasses to all male pipe fittings except flare fittings. Make sure to tighten every joint securely.

Note: If $\frac{1}{2}$ " pipe is used with **natural gas**, it should be no longer than 20'.

Important: **A shut-off valve (not included) in the gas line is required.** It provides for safety when the unit is not in use and for convenient maintenance and repair. It must be installed within 6 feet of the unit. Use a pipe joint compound resistant to all gasses on all male fittings except flare fittings.

GAS SUPPLY AND MANIFOLD PRESSURES:

For **natural gas** - normal 7" water column (w.c.), minimum 3 $\frac{1}{2}$ ", maximum 10 $\frac{1}{2}$ ". For **propane gas** - normal 11" w.c., minimum 8", maximum 13".

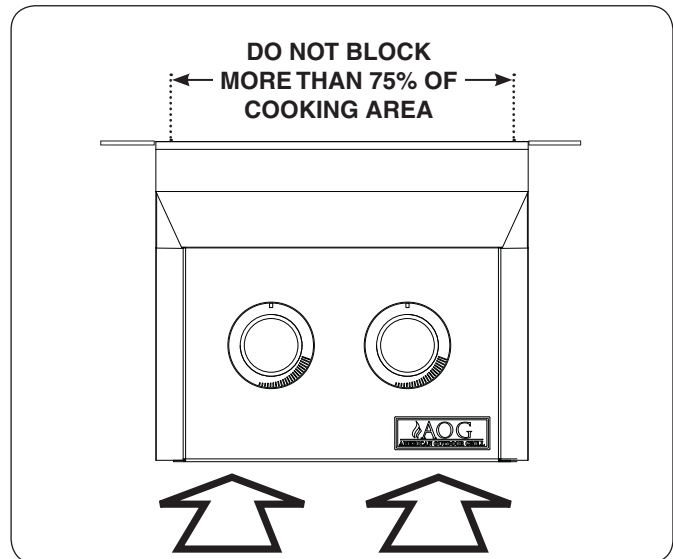

Fig. 10-1 Ventilation Diagram

ENCLOSURE REQUIREMENTS

VENTILATION (ALL ENCLOSURES)

**For All Piping Systems and All Gas Types:
(Natural Gas, Household Propane, L.P. Cylinder)**

FOR YOUR SAFETY, you must provide the openings listed below for replacement air and cross-ventilation of the unit enclosure.

One side of the enclosure shall be left completely open to the outside; **OR** 4 (minimum) ventilation openings **MUST** be created (reference Fig. 11-1):

Each opening must have a minimum of **10 sq. in.** of free area. The openings must be equally sized and unobstructed.

Two openings must be in the side walls of the enclosure, at the top level, and spaced at 180 degrees. The openings must begin 1" or less below the countertop level and end no more than 5" below the countertop level.

Two openings must be in the side walls of the enclosure, at the floor level, and spaced at 180 degrees. The openings must begin 1" or less above the floor level and end no more than 5" above the floor level.

To achieve the proper ventilation, you may use RHP venting panels (PN 5510-01) as shown. Contact your dealer.

KEEP THE VENT OPENINGS AND SURROUNDING AREA OF THE ENCLOSURE CLEAN AND FREE OF OBSTRUCTIONS AT ALL TIMES.

WARNING: Ventilation openings in side walls shall not communicate directly with other enclosures of the outdoor cooking gas appliance.

WHEN A PROPANE CYLINDER IS USED

When a propane cylinder is installed inside of the enclosure, the guidelines below **MUST** be followed. **FAILURE TO DO SO MAY CAUSE DAMAGE TO YOUR UNIT AND/OR PERSONAL INJURY.** Reference Fig. 11-2 for an example.

- Only a C.S.A. listed stainless steel connector can be connected to the unit.
- The supplied regulator is not required when using a propane cylinder.
- The regulator/hose assembly coming from the propane cylinder can only be connected to the above mentioned flex connector. **DO NOT connect the regulator/hose assembly directly to the double sideburner.** An adapter will be required.
- A non-combustible heatshield must be installed to protect the regulator/hose assembly and propane cylinder valve.
- **AOG offers propane tank door with tank tray models and a propane tank heatshield that rests directly on the tank to meet the cylinder install requirements. Propane tank door with tank tray shown in Fig. 11-3. Contact your dealer for ordering information.**

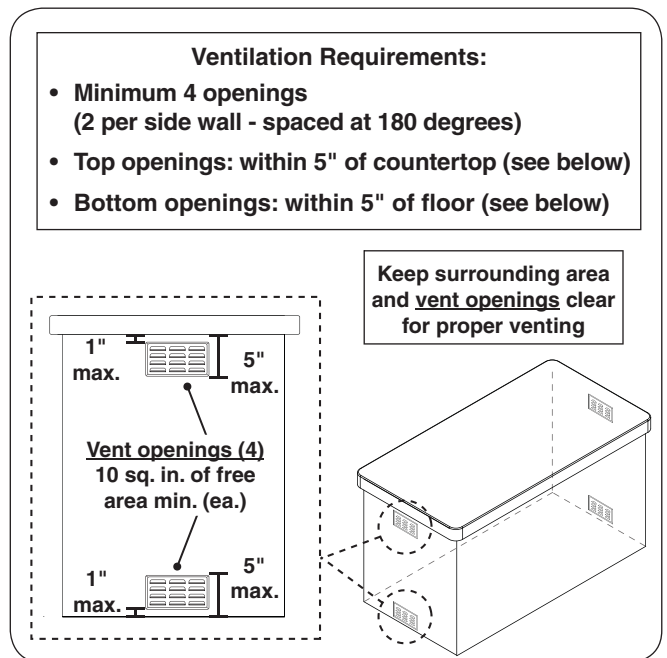

Fig. 11-1 Ventilation detail

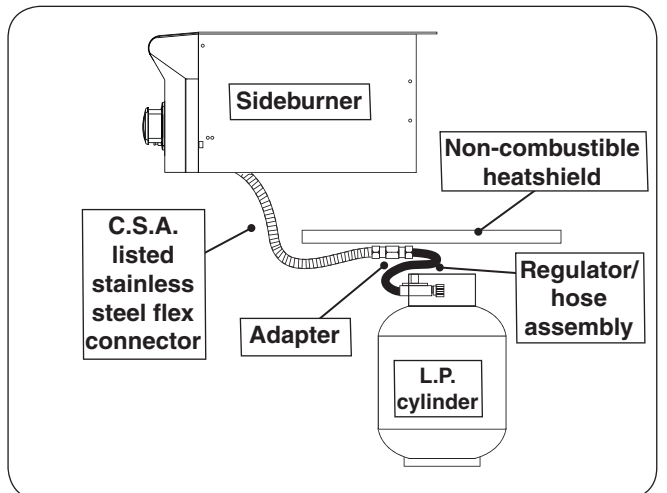

Fig. 11-2 Propane cylinder orientation

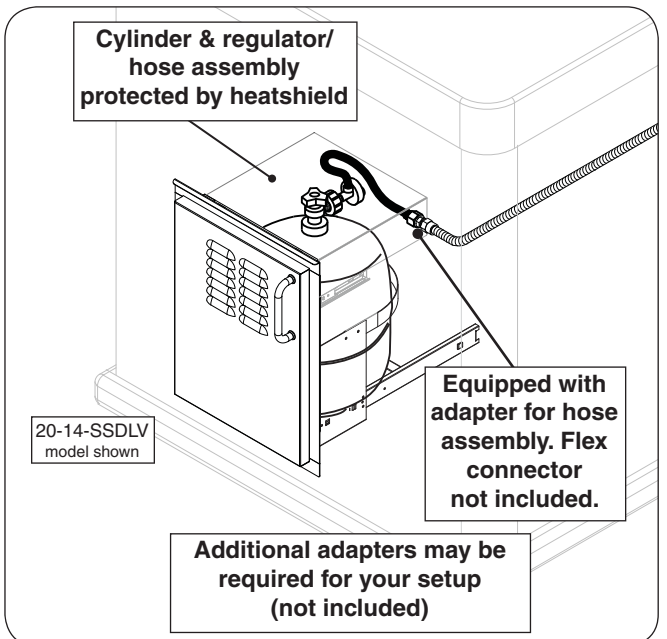

Fig. 11-3 Optional RHP door w/ tank tray

WHEN OPERATING THIS APPLIANCE WITH PROPANE, ALL INSTRUCTIONS AND WARNINGS MUST BE OBSERVED. FAILURE TO DO SO MAY RESULT IN A FIRE OR EXPLOSION CAUSING SERIOUS INJURY OR DEATH.

WARNING

This gas appliance, its enclosure, and the propane cylinder enclosure, if any, **MUST** be plumbed and vented in accordance with local building and safety codes and should be approved by local code enforcement officials. This appliance **MUST** be installed and operated according to the information below.

FAILURE TO PROPERLY VENT THE ENCLOSURE MAY RESULT IN A FIRE OR EXPLOSION CAUSING SERIOUS INJURY OR DEATH.

When using **propane gas**:

- **Propane gas** (also known as **L.P. gas**) is heavier than air and will accumulate or pool in an inadequately vented enclosure or recessed area.
- A leaking gas connection or valve unintentionally left open will create a hazard.
- If a pool of **propane gas** is ignited, an explosion will occur. Adequate venting at the floor level, or the lowest point where gas could accumulate, will eliminate this danger.

Refer to the **ENCLOSURE REQUIREMENTS** section.

Observe all local codes.

- DO NOT store a spare propane-gas cylinder under or near the enclosure.

INSTALLATION SAFETY GUIDELINES

THIS UNIT MUST BE INSTALLED IN SUCH A MANNER THAT ALL REQUIRED VENT OPENINGS ON THE UNIT ENCLOSURE REMAIN CLEAR AND FREE OF ALL OBSTRUCTIONS AT ALL TIMES AND DURING ALL WEATHER CONDITIONS. See the ENCLOSURE REQUIREMENTS section for details.

Important: FOR YOUR SAFETY, you must provide openings in the enclosure for replacement air and cross-ventilation (in case of possible leakage from gas connections or propane cylinders). See the ENCLOSURE REQUIREMENTS section for details.

The gas cylinder, regulator, and rubber hose must be in a location not subject to temps. above 125° F (51° C).

WHEN A PROPANE CYLINDER IS INSTALLED INSIDE OF THE ENCLOSURE, THE GUIDELINES FOUND IN THE ENCLOSURE REQUIREMENTS SECTION MUST BE FOLLOWED.

OPERATING THE UNIT SAFELY AND CORRECTLY

Every time you use the unit, **make sure that:**

1. The area around the enclosure is clear and free from combustible materials, gasoline and flammable vapors/liquids.
2. There is no blockage of the airflow through the vent openings located on the enclosure.
3. The hose is inspected (if applicable). See SAFE USE & MAINTENANCE OF PROPANE-GAS CYLINDERS section.

DO NOT store any combustible materials, gasoline, and any other flammable vapors/liquids in the vicinity of the unit. Provide adequate clearance for servicing and operation.

SAFE USE & MAINTENANCE OF PROPANE GAS CYLINDERS

IMPORTANT FOR YOUR SAFETY

READ AND FOLLOW ALL WARNINGS PROVIDED WITH THE PROPANE-GAS CYLINDER.

When operating this appliance with a propane-gas cylinder, these instructions and warnings **MUST** be observed.

FAILURE TO DO SO MAY RESULT IN A SERIOUS FIRE OR EXPLOSION.

CYLINDER/CONNECTOR REQUIREMENTS

- a. Propane-gas cylinders, valves, and hoses must be maintained in good condition and must be replaced if there is visible damage to either the cylinder or valve. If the hose is cut or shows excessive abrasion or wear, it must be replaced before using the gas appliance (see e.).
- b. This unit, when used with a cylinder, should be connected to a standard 5-gallon (20 lb.) propane-gas cylinder equipped with an OPD (Overfill Prevention Device). The OPD has been required on all cylinders sold since October 1, 1998, to prevent overfilling.
- c. Cylinder dimensions should be approximately 12" (30.5 cm) in diameter and 18" (45.7 cm) high. Cylinders must be constructed and marked in accordance with the *Specifications for Propane Gas Cylinders of the U.S. Department of Transportation (D.O.T.)* or the National Standard of Canada, *CAN/CSA-B339, Cylinders, Spheres, and Tubes for Transportation of Dangerous Goods*.
- d. The cylinder used must include a collar to protect the cylinder valve, and the cylinder supply system must be arranged for vapor withdrawal.
- e. The pressure regulator and hose assembly used must match the specification for Type I by *ANSI Z 21.58/CGA 1.6* (see Fig. 13-1).
- f. The propane-gas cylinder valve must be equipped with a cylinder connection coupling device, described as Type I in the standard defined in paragraph e. above. This device is commonly described as an Acme thread quick coupler.
- g. If the propane-gas cylinder comes with a dust plug, place the dust cap on the cylinder valve outlet whenever the cylinder is not in use.

QUICK COUPLER OPERATION

To connect the regulator/hose assembly to the propane-gas cylinder valve fitting: Press the hand nut on the regulator over the Acme thread fitting on the cylinder valve. Turn the hand nut clockwise to engage the threads and tighten until snug.

The use of pliers or a wrench should not be necessary. Only cylinders marked "propane" may be used.

To disconnect: Turn the hand nut counterclockwise until detached (Fig. 13-1).

Important: Before using the unit, and after each time the cylinder is removed and reattached, check the hose for wear (see a.) and check all connections for leaks. Turn off the unit valves and open the main cylinder valve, then check connections with soapy water. Repair any leaks before lighting the unit.

CAUTION: Always turn the propane cylinder main valve off after each use, and before moving the unit and cylinder or disconnecting the coupling. This valve must remain closed and the cylinder disconnected while the appliance is not in use, even though the gas flow is stopped by a safety feature when the coupler is disconnected.

Carefully inspect the hose assembly each time before the gas is turned on. A cracked or frayed hose must be replaced immediately.

If the appliance is stored indoors, the cylinder must be disconnected and removed. Disconnected cylinders must be stored outdoors, out of the reach of children, with threaded valve plugs tightly installed, and must not be stored in a building, garage, or any other enclosed area.

FOR YOUR SAFETY

- a. DO NOT store a spare propane-gas cylinder under or near this appliance.
- b. NEVER fill the cylinder beyond 80-percent full.
- c. IF THE INFORMATION IN a. AND b. IS NOT FOLLOWED EXACTLY, A FIRE CAUSING DEATH OR SERIOUS INJURY MAY OCCUR.

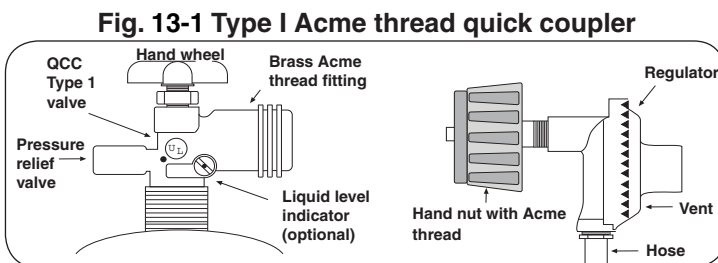

For propane ventilation requirements, see the ENCLOSURE REQUIREMENTS section.

UTILISATION SÛRE ET ENTRETIEN DES CYLINDRES DE GAZ DE PROPANE

IMPORTANT POUR VOTRE SÛRETÉ

LISEZ ET SUIVEZ TOUS LES AVERTISSEMENTS ÉQUIPÉS DE VOTRE CYLINDRE DE GAZ DE PROPANE.

En actionnant cet appareil avec un cylindre de gaz de propane ON DOIT observer ces instructions et avertissements.

LE MANQUE DE FAIRE AINSI PEUT AVOIR COMME CONSÉQUENCE UNE INCENDIE OU UNE EXPLOSION SÉRIEUSE.

CYLINDRE ET CONDITIONS ET

CARACTÉRISTIQUES DE CONNECTEUR

- Des cylindres et les valves de gaz de propane doivent être maintenus en bon état et doivent être remplacés s'il y a des dommages évidents au cylindre ou à la valve.
- Ce gril, une fois utilisé avec un cylindre, devrait être relié à un gallon de la norme 5 (20lb.) cylindre de gaz de propane équipé d'un OPD (remplissez au-dessus du niveau le dispositif d'empêchement). L'OPD a été exigé sur tous les cylindres vendus depuis octobre 1.1998 pour empêcher le remplissage excessif.
- Les dimensions de cylindre devraient être approximativement 12" (30.5cm) de diamètre et 18" (45.7cm) hauts. Des cylindres doivent être construits et marqués selon les caractéristiques pour des cylindres de gaz de propane du département des ETATS-UNIS du transport (D.O.T.) ou le niveau national du Canada, du CAN/CSA-B339, des cylindres, des sphères et des tubes pour le transport des marchandises dangereuses.
- Le cylindre doit inclure un collier pour protéger la valve de cylindre et le circuit d'alimentation de cylindre doit être assuré le retrait de vapeur.
- Le régulateur de pression et l'ensemble de tuyau utilisé doivent assortir les spécifications pour le type I par ANSI Z 21.58/CGA 1.6 (voir la figue. 14-1).
- La valve de cylindre de gaz de propane doit être équipée d'un dispositif d'accouplement de raccordement de cylindre, décrit comme type I dans la norme définie dans le e. de paragraphe ci-dessus. Ce dispositif est généralement décrit comme coupleur rapide de fil de point culminant.
- Si votre cylindre de gaz de propane vient avec une prise de la poussière, placez le bouchon anti-poussière sur la sortie de valve de cylindre toutes les fois que le cylindre n'est pas en service.

OPÉRATION DE COUPLEUR RAPIDE

Pour relier le régulateur/hose à l'ajustage de précision de valve de cylindre de gaz de propane: Serrez l'écrou de main sur le régulateur au-dessus de l'ajustage de précision de fil de point culminant sur la valve de cylindre. Tournez l'écrou de

main dans le sens des aiguilles d'une montre pour engager les fils et pour serrer jusqu'à ce que douillettement. L'utilisation des pinces ou de la clé ne devrait pas être nécessaire. Seulement le propane marqué par cylindres doit être employé.

Pour débrancher: Tournez l'écrou de main dans le sens contraire des aiguilles d'une montre jusqu'à isolé (fig. 14-1).

Important: Avant d'employer le gril, et ensuite chaque fois que le cylindre est enlevé et rattaché, examinez tous les raccordements pour déceler les fuites. Arrêtez les valves de gril et ouvrez la valve principale de cylindre, puis vérifiez les raccordements avec de l'eau savonneux. Réparez toutes les fuites avant d'allumer le gril.

ATTENTION: Tournez toujours la valve principale de cylindre de propane au loin après chaque utilisation, et avant de déplacer le gril et le cylindre, ou débrancher l'accouplement. Cette valve doit rester fermée et le cylindre a débranché alors que l'appareil n'est pas en service, quoique l'écoulement de gaz soit arrêté par un dispositif de sûreté quand le coupleur est débranché.

Inspectez soigneusement l'ensemble de tuyau chaque fois avant que le gaz soit allumé. Un tuyau fissuré ou effiloché doit être immédiatement remplacé.

Si l'appareil est stocké à l'intérieur, le cylindre doit être disconnected et a enlevé. Des cylindres Disconnected doivent être stockés dehors, hors de la portée des enfants, avec les prises de valve filettées étroitement installées, et ne doivent pas être stockés dans un bâtiment, le garage, ou n'importe quel autre secteur inclus.

POUR VOTRE SÛRETÉ

- Ne stockez pas un cylindre de gaz disponible de propane dessous ou ne vous approchez pas de cet appareil.
- Ne remplissez jamais cylindre au delà de 80 pour cent de plein.
- SI L'INFORMATION DANS "A" ET "B" N'EST PAS SUIVIE EXACTEMENT, UN FEU CAUSANT LA MORT OU DES DOMMAGES SÉRIEUX PEUT SE PRODUIRE.

Fig. 14-1 type coupleur rapide de fil de point culminant d'I

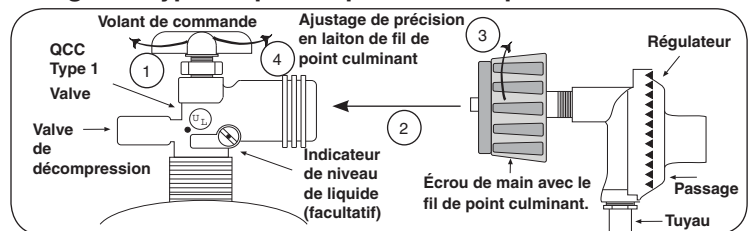

Pour la ventilation de propane, voir la section sur les exigences de boîtier.

COUNTER PREPARATION

Consult Table 1 for enclosure cut-out dimensions. If the counter or any supporting construction is combustible, the COMBUSTIBLE ENCLOSURE CUT-OUT section must be followed before beginning the installation.

This double sideburner must be supported by the stainless-steel hanger extending from the upper portion of the frame. The hanger rests on the left, right, and back of the countertop.

The control panel is designed to sit flush against the enclosure front wall (see Fig. 15-2). If the enclosure countertop extends beyond the front wall, creating a countertop overhang (see Fig. 15-1), it must be cut flush with the front wall for the width of the control panel or a gap will be created exposing the forward portions of the left and right side fire walls of the unit. Reference the MODEL SPECIFICATIONS section.

Note: It is not necessary to remove the control panel or control knobs to install this unit.

CONNECT THE GAS SUPPLY

Always ensure the orifices and regulator (if applicable) are set for the gas type your unit is to be installed to.

For propane cylinders:

For connecting a propane unit to a portable propane tank, read the safety warnings and follow the instructions in the section SAFE USE AND MAINTENANCE OF PROPANE GAS CYLINDERS.

Note: When a propane cylinder is installed inside of the enclosure, the guidelines found in the ENCLOSURE REQUIREMENTS section MUST be followed.

For household propane or natural gas units:

THE ATTACHED FLEX LINE AND REGULATOR MUST BE PROPERLY ATTACHED TO A RIGID GAS SUPPLY PIPE.

See Fig. 15-3.

CAUTION: Use only C.S.A. listed stainless-steel flex connectors within the enclosure.

WARNING

A rubber or plastic connector will rupture or leak, resulting in an explosion or serious injury if used inside the appliance enclosure.

1. Route the attached flex connector with regulator (located underneath the sideburner) to the gas-supply stub. (An adapter is required if the gas-supply stub is other than 1/2" in diameter.)
2. **Turn OFF the gas supply at the source.** Then connect the flex connector with regulator to the gas-supply stub. Use pipe joint compound that is resistant to all gasses on the male pipe fitting and tighten securely. **DO NOT use pipe joint compound to connect flare fittings.**

Note: The regulator may need to be disconnected from the flex connector to make the proper connections. Reconnect the flex to the regulator if removed.

Procedure continued on next page

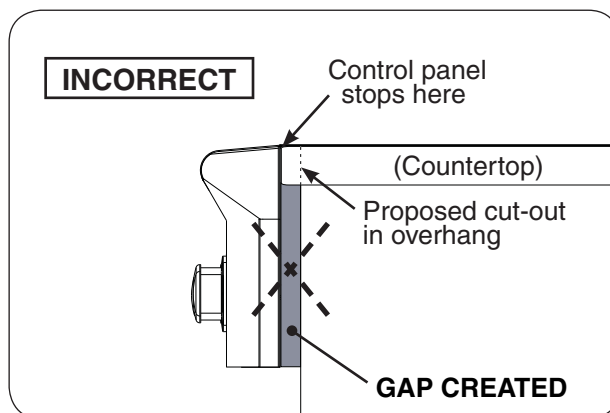

Fig. 15-1 Countertop overhang - incorrect cutout

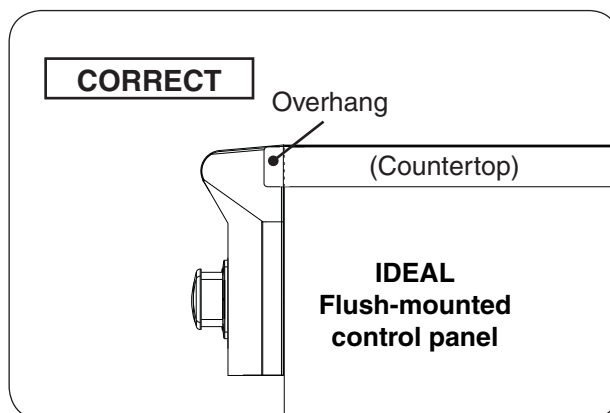

Fig. 15-2 Countertop overhang - correct cutout

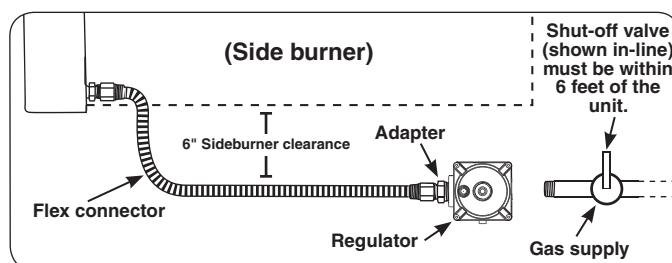

Fig. 15-3 Household propane & natural gas diagram

3. Turn all burner control knobs to the **OFF** position. Turn the gas supply on. Then carefully check all gas connections for leaks with a brush and half-soap/half-water solution before lighting. **Never use a match or open flame to test for leaks.**
4. Close the dedicated gas-supply shut-off valve.

SLIDE UNIT INTO ENCLOSURE

Slide the unit into place. Do not pinch, kink, or damage the gas connector line.

Note: Each side of the unit has a tab just behind the control panel. These tabs prevent the control panel from moving inward. If the tabs interfere with the unit sliding in (see Fig. 16-1), use pliers to bend them inward so that they clear the enclosure sides. Leave the tabs slightly out to ensure they still keep the control panel from moving inward (see Fig. 16-2).

Note: Additional tabs are provided on the side and rear panels and are only needed when installing in combustible framing. See **COMBUSTIBLE ENCLOSURE CUT-OUT** section for details.

POSITION THE BURNER CAPS

Place the burner caps so they are centered over each burner. Ensure that they rest securely in place.

INSTALL THE COOKING GRID

Carefully place the cooking grid onto the front and rear grid rests of the unit.

INSTALL THE BURNER COVER

Carefully place the cover over the cooking grid area of the unit. It is recommended to keep the cover on when the unit is not in use. **Do not operate the unit with the cover in place.**

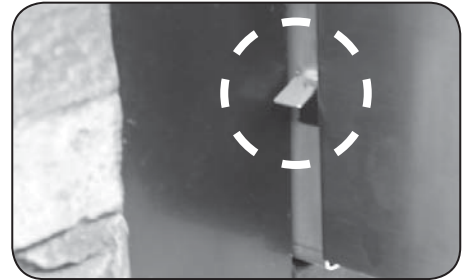

Fig. 16-1 Tab may interfere when sliding in unit

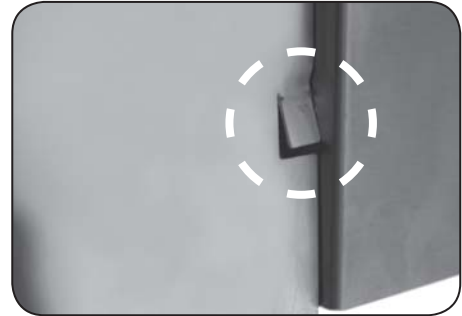

Fig. 16-2 Tab slightly bent in for clearance

Please use this page to record any information about your unit that you may want to have at hand.

ALLUMAGE DES INSTRUCTIONS (D'ALLUMAGE)

Lisez toutes les instructions avant l'allumage, et suivez ces instructions chaque fois vous lumière le unité.

ALLUMAGE COMMANDE ECLAIRAGE

Note: N'ouvrez pas plus d'une valve à la fois pour l'éclairage électronique ou manuel.

1. Ouvrez les couvercles ou enlevez les couvertures des brûleurs pour être Lit.
2. Tournez tous les boutons de commande de gaz à leurs positions de repos.
3. Allumez le gaz à sa source.

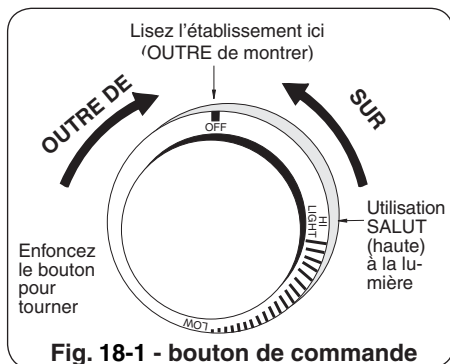

4. Appuyez sur le bouton de commande désiré, puis tout en appuyant son tour dans le sens antihoraire à la position HI LIGHT. Une fois que le brûleur s'allume, relâchez le bouton.

Note: Se il n'y a pas d'allumage, tournez immédiatement à la position OFF et répéter la séquence jusqu'à ce que le brûleur se allume.

ATTENTION : Si un brûleur ne s'allume pas dans cinq (5) secondes d'allumer le bouton de commande, enfoncez le bouton et tournez-le à la position de repos. ATTENDEZ CINQ (5) MINUTES avant de répéter l'étape 4. Si vous sentez le gaz, suivez les instructions sur la couverture de ce manuel. Si les brûleurs ne s'allument toujours pas après que plusieurs tentatives, se rapportent aux instructions pour l'éclairage manuel.

5. Répétez l'étape 4 pour que chaque brûleur additionnel soit Lit.

ÉCLAIRAGE MANUEL

ATTENTION: Attendez toujours cinq (5) minutes le gaz pour se dégager après que n'importe quelle tentative non réussie d'éclairage.

1. Suivez les étapes 1 à 3 (à gauche).
2. Insérez soit un brûlant long baril briquet au butane, un match à longue tige de brûlure, ou une allumette en feu détenues par un titulaire d'extension de fil À travers les grilles de cuisson du brûleur (Fig. 18-2). Tenez la flamme contre le bord du brûleur.
3. Tout en maintenant le match ou flamme d'un briquet à proximité du brûleur, appuyez sur le bouton de contrôle approprié et en appuyant son tour dans le sens antihoraire à la position **LIGHT HI**. Retirez le briquet ou des allumettes quand le brûleur s'allume, puis relâchez le bouton de commande.
4. Si le brûleur ne se allume pas dans les cinq (5) secondes de tourner le bouton de commande, **appuyez immédiatement sur le bouton et tournez la valve sur OFF**. Attendez cinq (5) minutes avant de répéter les étapes 2 à 4 des instructions du manuel d'éclairage.

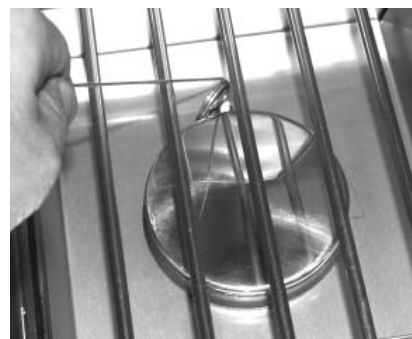

Fig. 18-2 - Éclairage manuel

ARRÊT DU UNITÉ

Pour couper le unité, diminuez chaque bouton de commande de valve et tout en pressant tour il dans le sens des aiguilles d'une montre à la position de repos.

Fermez toujours la valve de la fourniture de gaz après chaque utilisation du unité.

EN EMPLOYANT UN RÉSERVOIR DE PROPANE PORTATIF

Des réservoirs de propane sont équipés d'un dispositif d'arrêt de sûreté qui peut ne pas causer le bas ou aucunes pression de gaz/flamme aux brûleurs si le fonctionnement et l'allumage des instructions ne sont pas suivis exactement (voir la note importante dans la section de dépannage pour plus de détails.)

LIGHTING (IGNITION) INSTRUCTIONS

Read all instructions before lighting, and follow these instructions each time you light the unit.

SPARK IGNITION LIGHTING

Note: DO NOT turn on more than one valve at a time for either electronic or manual lighting.

1. Open lid(s) or remove cover(s) from burner(s) to be lit.
2. Turn all gas control knob(s) to their **OFF** position(s).
3. Turn on the gas at its source.

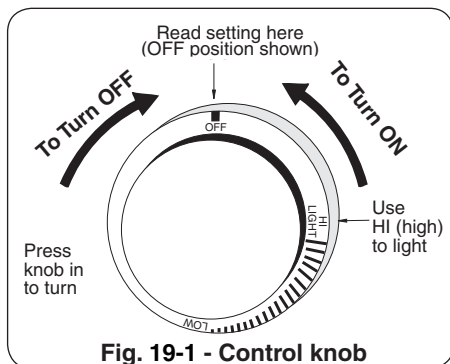

4. Depress the desired control knob, then while pressing turn it counterclockwise to the **HI LIGHT** position. Once the burner lights, release the knob.

Note: If there is no ignition, immediately turn to OFF position and repeat sequence until the burner ignites.

CAUTION: If a burner does not light within five (5) *seconds* of turning on the control knob, depress the knob and turn it to the **OFF** position. **WAIT FIVE (5) MINUTES** before repeating step 4. If you smell gas, follow the instructions on the cover of this manual. If the burners still do not light after several attempts, refer to the instructions for manual lighting.

5. Repeat step 4 for each additional burner to be lit.

WHEN USING A PORTABLE PROPANE TANK

Propane tanks are equipped with a safety shutdown device that may cause low or no gas pressure/flame at the burners if operating and lighting instructions are not followed exactly (See important note in the TROUBLESHOOTING section for more details.)

MANUAL LIGHTING

CAUTION: Always wait five (5) minutes for gas to clear after any unsuccessful lighting attempt.

1. Follow steps 1 through 3 (left).
2. Insert either a burning long-barrel butane lighter, a burning long-stem match, or a burning match held by a wire extension holder through the cooking grids to the burner (Fig. 19-2). Hold the flame against the edge of the burner.
3. While holding the match or lighter flame next to the burner, depress the appropriate control knob and while pressing turn it counterclockwise to the **HI LIGHT** position. Remove the lighter or match when the burner lights, and release the control knob.
4. If the burner does not light within five (5) seconds of turning the control knob, **immediately depress the knob and turn the valve to OFF**. **WAIT FIVE (5) MINUTES** before repeating steps 2 through 4 of the MANUAL LIGHTING instructions.

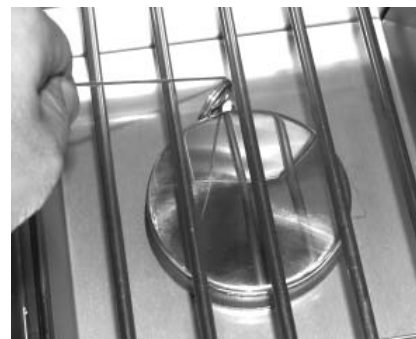

Fig. 19-2 - Manual lighting

SHUTTING OFF THE UNIT

To shut off the unit, depress each valve control knob and while pressing turn it clockwise to the **OFF** position.

Always close the valve from the gas supply after each use of the unit.

CARE & CLEANING

APPLIANCE MUST BE COMPLETELY COOL WHEN CLEANING. DO NOT SPRAY ANY CLEANER OR LIQUIDS ON THE APPLIANCE WHEN HOT.

The appliance *must* be cleaned as often as once a month (depending on use) to prevent grease build-up and other food deposits.

A clean and well maintained appliance prevents the risk grease fires. Reference the GRILL MAINTENANCE AND SAFETY section.

INTERIOR

THE **BURNER PORTS** MUST BE KEPT CLEAN TO ENSURE PROPER IGNITION AND OPERATION.

Remove the burner (see the CHECK BURNER ORIFICES section) and clean the ports as required. Remove the burner cap(s) and use a soft, stiff brush (an old toothbrush) to clean the ports in the burner and the underside of the burner cap.

Also inspect and clean the burner inlet for insects and nests. A clogged burner can lead to a fire in the bottom of the appliance.

The inside of the appliance may be cleaned periodically with oven cleaner if desired. Follow the oven cleaner instructions for proper use.

Be careful not to get oven cleaner on the outside surface of the appliance as it can permanently damage the finish.

EXTERIOR

Stainless steel surfaces when exposed to temperatures produced by the grilling process will change color. The stainless steel will change color from silver to brown and blue. This can be removed by using stainless steel cleaner.

Clean your appliance by first using stainless steel grill cleaner to remove grease and dirt. Always wipe with the grain (See Fig. 20-1). Next, apply stainless steel polish and wipe down using polish wipes to restore the stainless steel color.

If your appliance is installed in a seaside (salt air) or poolside (chlorine) location, it will be more susceptible to corrosion and must be maintained/cleaned more frequently. Do not store chemicals (such as chlorine or fertilizer) near your stainless steel appliance.

Due to the nature of stainless steel, surface iron oxide deposits may appear. Do not be alarmed – these deposits are removable with stainless steel cleaner through prompt and periodic maintenance. If not attended to promptly, permanent pitting may occur.

By following these recommendations, you will enjoy the beauty and convenience of your appliance for many years to come.

PROTECTING YOUR APPLIANCE FROM THE WEATHER

An optional cover will protect your appliance when not in use. Allow to cool before covering. Please specify the model number and serial number of your appliance when ordering a cover.



Fig. 20-1 Wipe with grain

CONVERT GAS TYPE / CHECK BURNER ORIFICES

CAUTION: Make sure the unit is at a safe temperature and is isolated from gas and electrical supplies before beginning.

For your safety, exercise caution, and make sure you have adequate hand protection, such as gloves, when handling metal parts.

APPLY CONVERSION LABEL

This unit comes from the factory configured for one type of gas as marked on the label behind the control panel.

When the unit is converted, the label for the new gas (included at original shipping) MUST be filled out and applied next to the existing label mentioned above.

CONVERT REGULATOR

The gas regulator, located at the end of the flex connector, must be set for the type of gas used to fuel the unit. To check the regulator setting, remove the cap in the center of the regulator (Fig. 21-1, A). Holding the cap vertical (see Fig. 21-2, B), the letters at the bottom of the plastic stalk indicate the gas type for which the regulator is currently configured.

If the text on the bottom of the regulator stalk does not match the gas type connected to the unit, remove the stalk from the cap, invert, and replace into center of cap. Replace cap on the regulator, screwing down until snug.

CONVERT GAS ORIFICES

When converting the unit to a different gas type, each burner's orifice must be replaced with the corresponding orifice for the new gas.

See MODEL SPECIFICATIONS TABLE, Table 1 at the beginning of this document to determine the proper orifice sizes for each burner.

Important: It is critical to the operation of each burner that its orifice be fully inserted into the center of its orifice opening.

WARNING

HAZARDOUS OVERHEATING WILL OCCUR IF A NATURAL-GAS ORIFICE IS USED WITH PROPANE GAS.

CONNECT TO NEW GAS SUPPLY

Plumb the unit as appropriate for the new gas supply. (Additional components may be needed for your specific setup.) **Be sure to leak test at all connections.**

Continued on next page

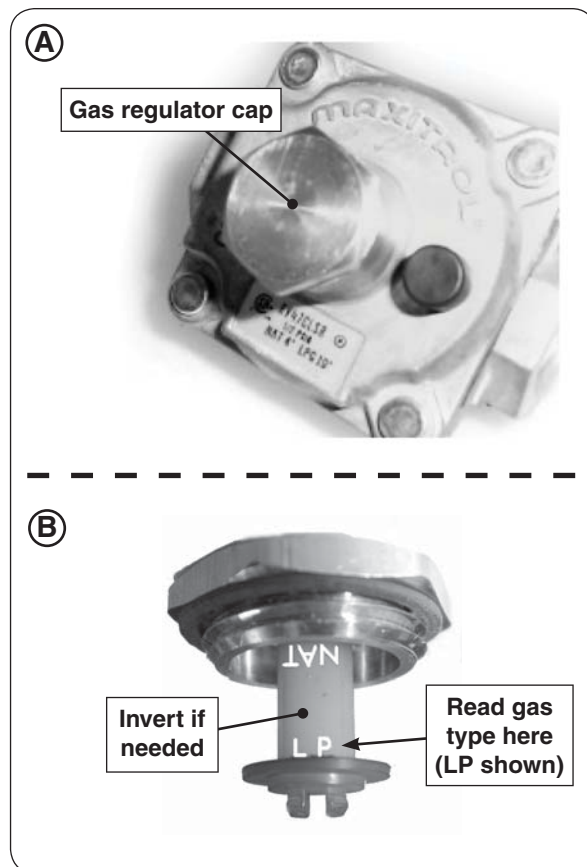

Fig. 21-1 Convert regulator

CONVERT/CHECK DOUBLE SIDE BURNER ORIFICE

1. Lift the side burner lid. Then remove the cooking grid and side burner cap and set them aside.
2. Remove the control panel. See the CONTROL PANEL REMOVAL section for details.
3. Reach up under the burner support and remove the burner retaining clip (see Fig. 22-1), located at the rear of the burner pipe.
4. Remove the burner cap and carefully lift the burner up and out, clearing the ceramic electrode (see Fig. 22-2), and pulling the burner tube away from the orifice, located on the end of the orifice holder on the left side of the unit (see Fig. 22-3).

Note: You do not have to lift the burner completely out of the unit to access the orifice.

5. Using a 3/8" socket, remove orifice from the orifice holder (see Fig. 22-3) and check the number stamped on the orifice face.
6. If an orifice change is necessary, replace the orifice with the correct size.

Note: To protect the manifold threads when placing the new orifice, start the threading manually, and then tighten with the nut driver.

7. Replace the sideburner tube over the orifice, aligning the burner over the electrode, taking care not to detach it from the wire.
8. Replace the burner retaining clip (underneath burner), and burner cap.
9. Repeat steps 3. through 8. for the second burner.
10. Replace the control panel and control knobs.
11. Replace the grid and cover.

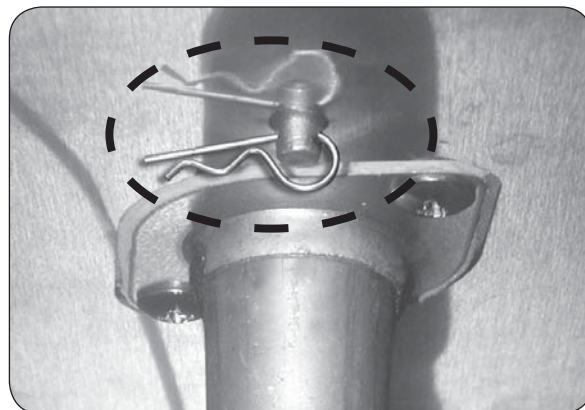

Fig. 22-1 Remove burner clip

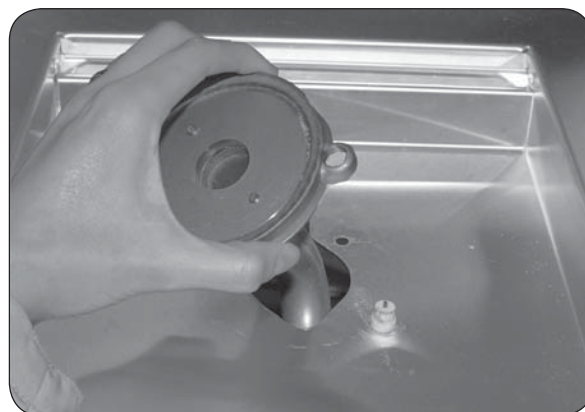

Fig. 22-2 Remove burner

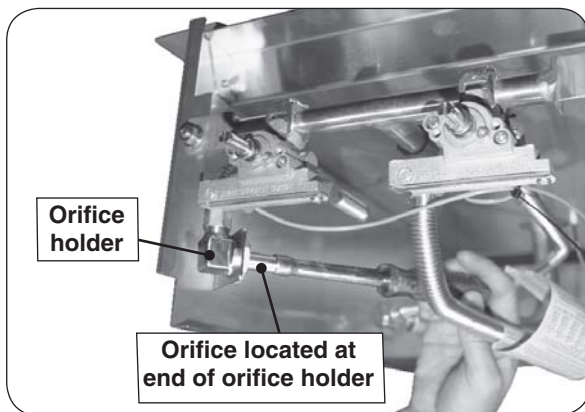

Fig. 22-2 Orifice location

AIR SHUTTER ADJUSTMENT

Air shutters are preset at the factory based on the gas the sideburner is built to burn. However, altitude or other local conditions may require air shutter adjustment for proper combustion.

The flames from a properly adjusted sideburner will touch the burner ports and appear mostly blue.

If the flames are orange, “lazy”, or lift off the burner ports, then adjust the sideburner air shutter using the following steps.

The air shutters are located at the end of the burner assemblies, behind the control panel. They can safely and easily be adjusted while the unit is lit.

CAUTION: Do not touch the sideburner surrounding top area, as it will be hot while adjusting the air shutter.

1. Remove the control panel. See the CONTROL PANEL REMOVAL section for details.
2. Replace the control knobs back on to the valve stems.
3. Light the sideburner following the LIGHTING INSTRUCTIONS section.
4. Loosen the front burner air shutter adjustment screw, then use the tip of a screwdriver to open or close the air shutter until the flames appear blue and touch the burner ports.
5. Retighten the adjustment screw.
6. Repeat for rear burner air shutter.

Should you have difficulty accessing the rear burner air shutter, you may shut down, remove the rear burner (when cool), then adjust the air shutter to the same opening as the already adjusted front burner. (See CONVERT/CHECK SIDE BURNER ORIFICE section to remove rear burner.) Be sure to properly reinstall rear burner when complete.

7. Once all adjustments are complete; be sure the unit is off and remove the knobs, then replace the control panel and knobs.

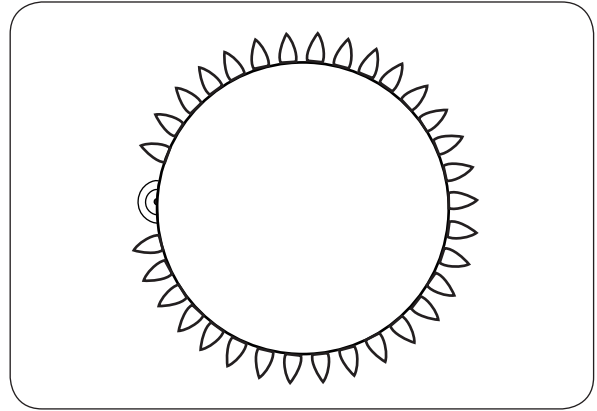

Fig. 23-1 Flame pattern

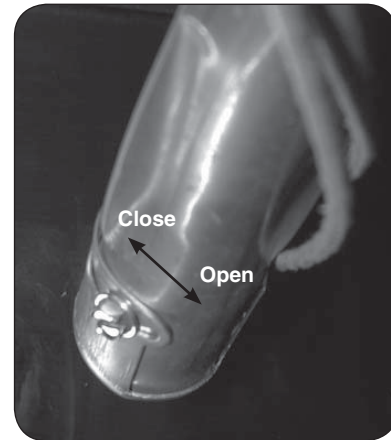

Fig. 23-2 Adjust air shutter

CONTROL PANEL REMOVAL

To remove the control panel:

1. Turn the control knobs to the OFF position and turn off the gas supply to the unit.
2. Pull the control knobs from the stems and set aside (A).
3. Using a Phillips screwdriver, unscrew and remove the control panel fastener screws and washers (located on the sides of the control panel). Retain the screws for later re-installation (B).
4. Carefully open the control panel by lifting and pulling the control panel from the frame (C).

Important: During reinstallation; prior to opening the gas shut-off valve, be sure the control knobs are in the OFF position.

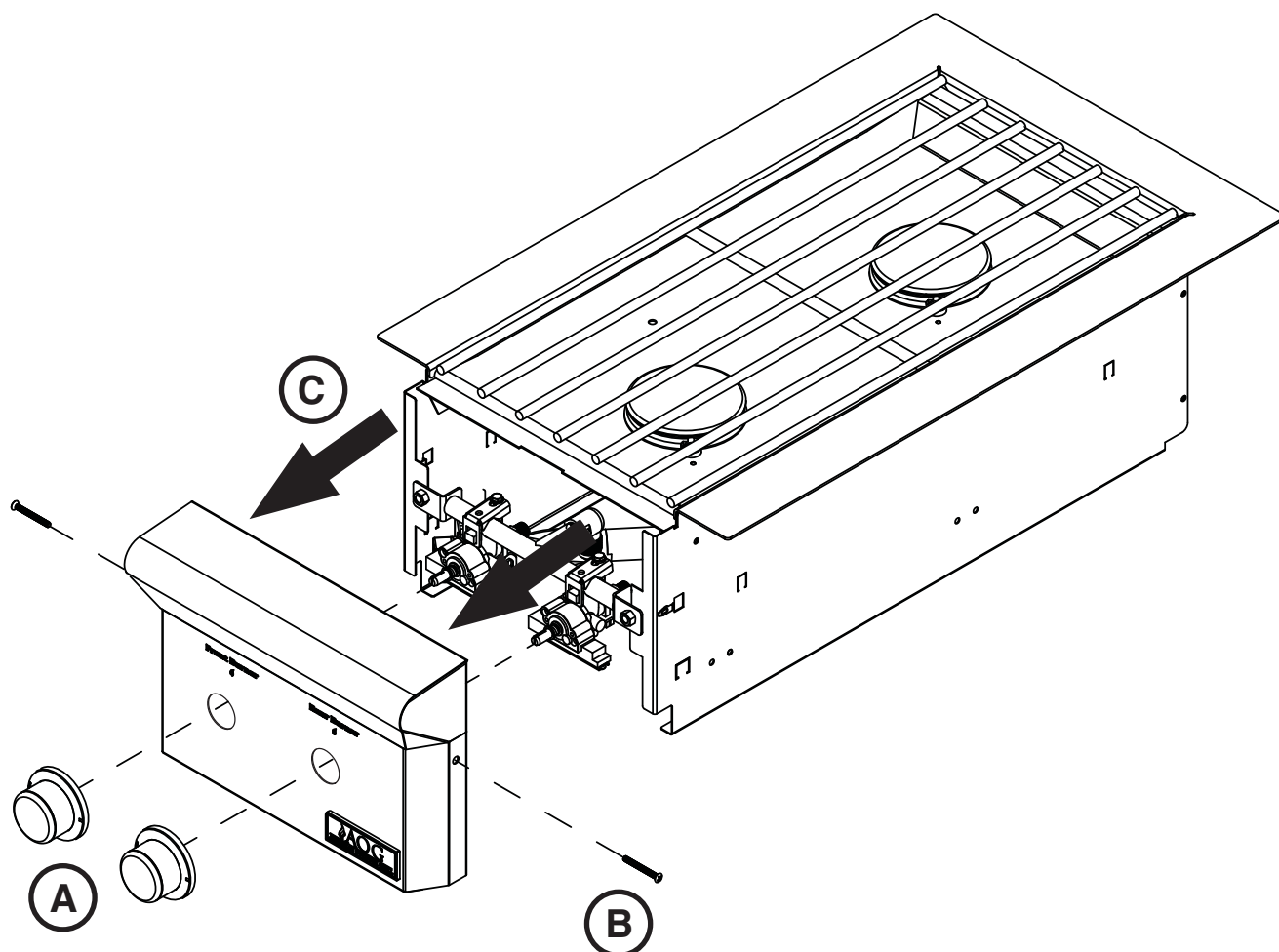

VALVE "LOW" SETTING ADJUSTMENT

Stability of the "low" setting on the burners may vary due to wind direction, unit configuration, and position. If your burner goes out when set on low, adjust the valve "low" setting.

To adjust the valve "low" setting:

1. Ensure the unit is completely cool and the knobs are in the OFF position.
2. Remove the control knobs and control panel. See the CONTROL PANEL REMOVAL section for panel removal instructions.
3. Re-install the control knobs on the valve stems with the control panel removed.
4. Light the burner on HIGH, then immediately turn the burner to LOW setting. While the burner is lit, remove the control knob from the valve.
5. Locate the FLATHEAD adjustment screw found above the valve stem and below the manifold (see Fig. 25-1).
6. Using a flathead screwdriver, slowly turn the adjustment screw a little at a time (30° to 45°) in either direction. Adjust the screw as needed until the flame is approximately $\frac{1}{4}$ " in height from all the burner ports, and the flames are stable.

CAUTION: Only adjust the FLATHEAD screw. Adjusting other screws may result in a dangerous gas leak.

7. Once the appropriate setting is reached, re-install the control knob and shut off the burner valve.
8. Repeat this procedure for the other burner valve, if needed.
9. Re-install the control panel.

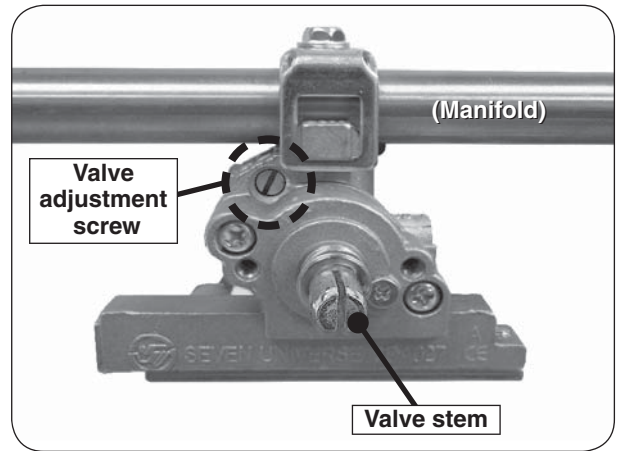

Fig. 25-1 Valve adjustment screw location

NOTES PAGE

Please use this page to record any information about your unit that you may want to have at hand.

TROUBLESHOOTING

If you have trouble with the unit, please use this list to identify the problem. By trying one or more of the solutions to the possible cause, you should be able to solve the problem. If this list does not cover your present problem, or if you have other technical difficulties with the unit, please contact your local dealer.

PROBLEM	POSSIBLE CAUSE	CORRECTION
Ignition system failure	<ol style="list-style-type: none"> 1. Improper air shutter adjustment 2. No spark generated at the valve 3. Low gas pressure 4. Front carry-over port 5. Ignition wire disconnected 	<ol style="list-style-type: none"> 1. Adjust air shutters. 2. Retry to light. If ignition failure continues, contact dealer for valve replacement. 3. Have the gas co. check supply pressure. 4. Clean burner ports. 5. Reconnect wire to valve.
Insufficient heat / low flame	<ol style="list-style-type: none"> 1. Burner ports clogged 2. Improper air-shutter adjustment 3. Using propane orifice for natural gas 4. Low gas pressure/flame (propane) 5. Low gas pressure/flame (natural) 6. L.P. regulator hose cracked due to age 	<ol style="list-style-type: none"> 1. Remove burners and clean out ports. 2. Adjust air shutters. 3. Check/change orifices. 4. Refill propane tank, or reset propane tank safety*: Shut off all valves (including propane tank) and follow lighting instructions exactly. 5. Have the gas co. check pressure at unit. 6. Replace L.P. regulator hose.
Uneven heating	<ol style="list-style-type: none"> 1. Burner ports partially blocked by debris 2. Small spiders or insects in burner 3. Improper air shutter adjustment 	<ol style="list-style-type: none"> 1. Remove burners and clean out ports. 2. Inspect burners and orifices for spider webs or other debris that may block flow. 3. Adjust air shutter.
Burner goes out on LOW	<ol style="list-style-type: none"> 1. Valve "Low" setting needs adjustment 	<ol style="list-style-type: none"> 1. See the VALVE "LOW" SETTING ADJUSTMENT section for details.

Table 2

Note: *Propane tanks are equipped with a safety shutdown device that may cause low or no gas/flame at the burners if operating and lighting instructions are not followed exactly. **If you suspect the propane tank safety shutoff is in effect:** 1) Shut off all grill valves. 2) Shut off tank valve. 3) Open and close a main burner valve. 4) Open tank valve. 5) Follow the LIGHTING INSTRUCTIONS. Lighting instructions are located in the owner's manual and printed on the front face of the unit. If the problem persists, continue troubleshooting, or contact your local dealer or distributor for assistance.

WARRANTY

AMERICAN OUTDOOR GRILL LIMITED WARRANTY

American Outdoor Grill warrants your grill to be free from defects in material and workmanship.

American Outdoor Grill stainless-steel burners are warranted for **FIFTEEN (15) YEARS**. All other American Outdoor Grill parts are warranted for **TEN (10) YEARS**. (Except as noted below.)

American Outdoor Grill infrared burners and vaporizer panels are warranted for **THREE (3) YEARS**.

American Outdoor Grill ignition systems (excluding batteries) and accessories (including sideburners, motors, and thermometers) are warranted for **ONE (1) YEAR**.

A COPY OF YOUR SALES SLIP FOR PROOF OF PURCHASE IS REQUIRED

This warranty applies to the original purchaser for products which are installed in the United States or Canada and which are operated and maintained as intended for single family residential usage. This warranty is valid only with proof of purchase, shall commence on the date of purchase, and shall terminate (both as to original and any replacement products) on the anniversary date of the original purchase of the product stated on the above schedules.

This warranty covers defects in material and workmanship. This warranty **does not** cover parts which become defective as a result of negligence, misuse, use not in compliance with the Owner's Manual/Installation Instructions, accidental damage, improper handling, improper storage, improper installation, **lack of required routine maintenance** (as specified in the Owner's Manual/Installation Instructions), electrical damage, local gas impurities or failure to protect against combustibles. Product must be installed (and gas must be connected) as specified in the Owner's Manual/Installation Instructions by a **qualified professional installer**. Modifications to products which are not specifically authorized will void this warranty. Accessories, parts, valves, remotes, etc. when used must be Peterson products or this warranty is void. Warrantied items will be repaired or replaced at Peterson's sole discretion. This warranty **does not** apply to rust, corrosion, oxidation, or discoloration unless the affected part becomes inoperable.

This warranty **does not** cover labor or labor related charges, except as provided by separate specific written programs from the Peterson Co. All repair work must be performed by a qualified professional service person and requires prior approval of Peterson.

Peterson may require the defective product or part to be returned to the factory to determine the cause of failure. Peterson will pay freight charges if the product or part is determined to be defective. This warranty does not cover breakage in shipment from our (Independent) distributor to its customer if the damage is determined to have occurred during that shipment.

This warranty specifically excludes liability for **indirect, incidental**, or consequential damages. Some states and provinces do not allow the exclusion or limitation of incidental or consequential damages, so the above exclusion may not apply to you. This warranty gives you specified legal rights, and you may have other rights that vary from state to state or province.

For additional information regarding this warranty, or to place a warranty claim, contact the R. H. Peterson dealer where the product was purchased.

**TO REGISTER YOUR PRODUCT ONLINE GO TO: WWW.AMERICANOUTDOORGRILL.COM,
AND CLICK ON PRODUCT REGISTRATION. THANK YOU FOR YOUR PURCHASE.**

Quality Check			Date: _____		
Burner Orifices	Nat.	L.P.	Leak Test: _____	Model#:	_____
Main:	_____	_____	Burn Test: _____	Serial#:	_____
Other:	_____	_____	Gas Type: <u>Nat. / L.P.</u>	Air Shutter:	_____
				Inspector:	_____